

MÉTALEC

STEEL DOORS & FRAMES



Strength of expertise

Over the years, Métalec has become a recognized specialist as a manufacturer of steel doors and frames. Knowledge and experienced know-how has permitted them to respond to a variety of needs in commercial, industrial and institutional projects.

Concerned about customer satisfaction and well executed work, Métalec has surrounded itself with qualified staff, offering a personalized service for either standard or custom made designs.

Primarily serving a distribution network (specialized in construction), located in Canada, the United States and abroad, Métalec manufactures durable and reliable products based on automated production equipment and quality control performed at each step in its process.

At Métalec, the product diversity can satisfy all needs of steel doors in a new construction or renovation. Among the range of products offered, we manufacture fire rated doors, security doors, acoustic (sound proof) doors, stainless steel doors and standard steel doors insulated or not.

Knockdown or welded steel door frames, in stainless steel or with a thermal break supplement the product line to offer complete sets that suit all requirements.

Métalec, strength of expertise!



Knockdown steel frames p. 4

Welded steel frames p. 6

Thermal break frames p. 8

Architectural frames p. 10

Acoustical doors and frames p. 12

Steel doors p. 14

Security doors p. 20

Stainless steel doors and frames p. 24

Certifications and specifications p. 26

Fire labelling guide p. 28



Knockdown steel frames

The knockdown steel frames from the “CM” series, manufactured by Métalec, are designed to be installed once the partition is in place. The double return of the knockdown steel frame enables a close fit without damaging the wall finish. Six tension anchors allows an adjustable installation on each frame ensuring a solid binding and a true alignment. The two strap anchors are welded at the bottom of the jambs. The knockdown frames takes a few minutes to install and can be relocated, if necessary, without damage.

“CM” SERIES

- The knockdown steel frames are manufactured using 18, 16 or 14 gauge galvanized steel;
- This type of frame is removable and has four corner tabs welded at the jambs to facilitate the jambs and head assembly;
- Each jamb has two adjustable tension anchors and two strap anchors welded to the base;
- The head has two adjustable tension anchors. In double openings, the head has two rubber bumpers;
- The hinge jamb is prepared to receive three standard hinges of 114 mm x 102 mm (4-1/2" x 4");
- The strike jamb is prepared to receive one ASA type strike of 32 mm x 124 mm (1-1/4" x 4-7/8") or one T-strike of 29 mm x 70 mm (1-1/8" x 2-3/4") and has three rubber bumpers;
- The knockdown steel frames are available with a 20, 45, 90 or 180 minute fire rating;
- The hardware preparation and location is in accordance with the standards of the “American National Standard Institute”.

“CM-20” SERIES

- The knockdown steel frames from the “CM-20” series are designed to be used with 35 mm (1-3/8") thick hollow core wooden doors;
- These frames are manufactured using 20 gauge satin finish galvanized steel. They are frequently used in the accommodation and condominium buildings.
- The knockdown steel frames are removable and have four corner tabs welded at the jambs to facilitate the jambs and head assembly;
- Each jamb has two adjustable tension anchors and two strap anchors welded to the base;
- The head has two adjustable tension anchors;
- The hinge jamb is prepared to receive two hinges of 76 mm x 76 mm (3" x 3") with 16 mm (5/8") radius corners;
- A third hinge preparation is available upon request;
- The hinge reinforcements are manufactured in 16 gauge galvanized steel, pre-drilled and welded by electrical resistance at the jamb;
- The strike jamb is prepared to receive one standard T-strike of 29 mm x 70 mm (1-1/8" x 2-3/4") and has two rubber bumpers.

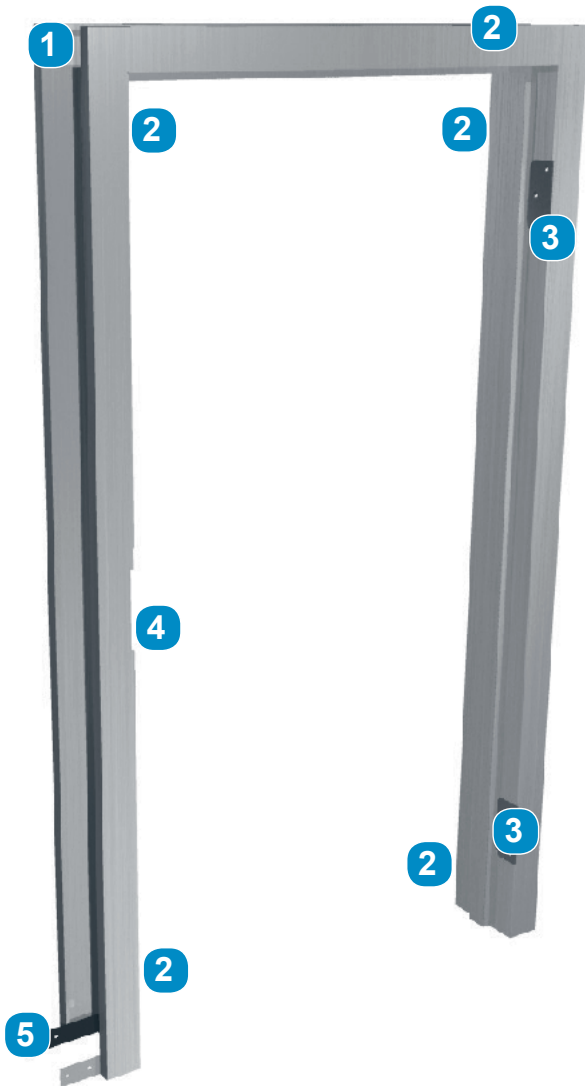
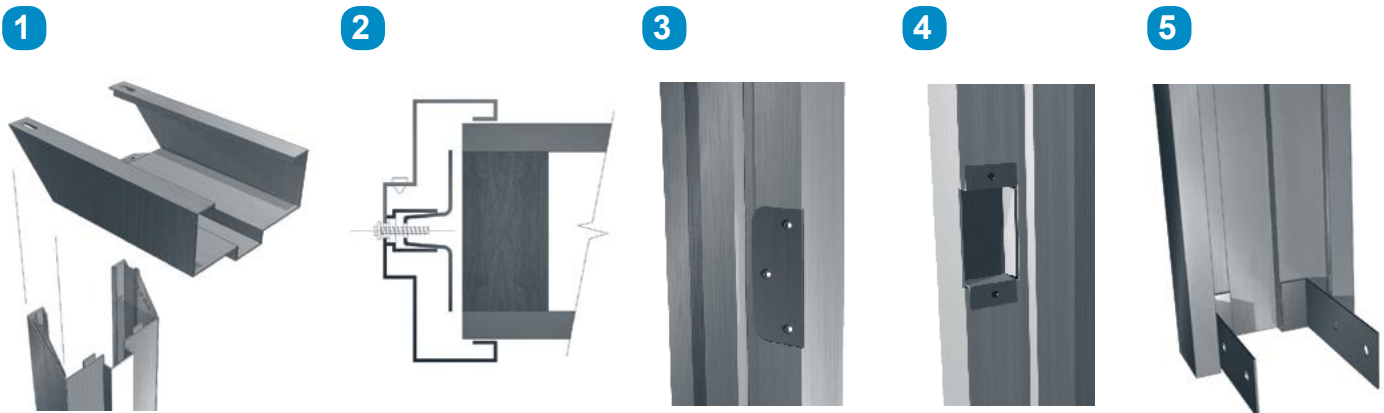

ILLUSTRATION:

- 1- Corner assembly for knockdown frame
- 2- Adjustable tension anchor for knockdown frame only
- 3- 16 gauge hinge reinforcement
- 4- Standard strike preparation
- 5- Strap anchor at the base for knockdown frame

Illustration: "CM-20" Series



N.B.: Other hardware preparations are also available upon request.

Welded steel frames

The welded steel frames from the “CS” series are designed to be installed before the construction of the interior partitions. They offer an increased durability allowing a greater longevity.

“CS” SERIES

- The welded steel frames from the “CS” series are manufactured using 18, 16, 14 or 12 gauge galvanized steel;
- The mitred corners are welded using one of the 2 methods:
 - Standard > the joints are welded by carrying out a continuous weld bead only on the inside faces of the mitred corners.
 - Optional > the joints are welded by carrying out a continuous weld bead on the inside of the entire frame profile.
- All welded corners are ground smooth and primed to achieve a good looking finish;
- The steel frames have two temporary spreader bars welded at the base of the frame. They have six frame anchors adapted to various types of wall constructions and two floor anchors;
- The single openings have three rubber bumpers per strike jamb and the double openings have two rubber bumpers on the head;
- The frames are prepared to receive the hinges and the strike as specified in the knockdown frame section;
- The hinge reinforcements are protected by mortar boxes when they are installed in concrete block walls.

These frames are available with a 20, 45, 90 or 180 minute fire rating. The hardware preparation and location is in accordance with the standards of the “American National Standard Institute”.



ILLUSTRATION:

- 1- 10 gauge angular hinge reinforcement
- 2- ANSI A115.1 strike preparation (ASA)
- 3- Floor anchor (ATT #3)
- 4- Masonry wall anchor (ATT #5)
- 5- Existing wall anchor (ATT #6)
- 6- Steel stud anchor (ATT #8)
- 7- Masonry wall anchor (ATT #4)
- 8- Wood stud anchor (ATT #7)
- 9- 10 gauge hinge reinforcement

1



2



3



SEVERAL TYPES OF ANCHOR:

4



5

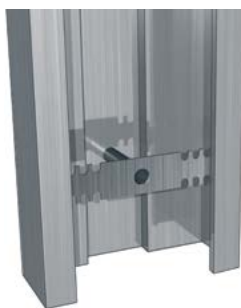

6

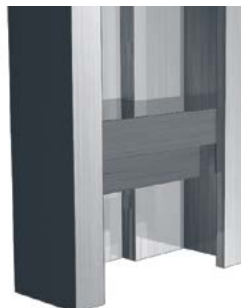

7



8



N.B.: Other hardware preparations are also available upon request.

Thermal break frames

Métalec manufactures steel frames designed specifically for the exterior openings, adapting perfectly to the climatic fluctuations.

The thermally broken frames are manufactured in two parts separated by a low thermal conductive PVC flashing which eliminates thermal bridge. The two parts are retained together by a Z-shaped steel reinforcement eliminating thermal bond between the exterior and interior door frame faces.

Technical details

- The steel frames are manufactured using 16 or 14 gauge galvanized steel;
- The frames are supplied knockdown or welded;
- The frame anchors are determined according to the type of installation and wall composition;
- The frames are prepared to receive the specified hardware;
- The single openings have three rubber bumpers per strike jamb and the double openings have two rubber bumpers on the head.

Recommendations

To optimize a low conductivity in your steel frame, we recommend the use of a polyisocyanurate insulated door, as manufactured by Métalec

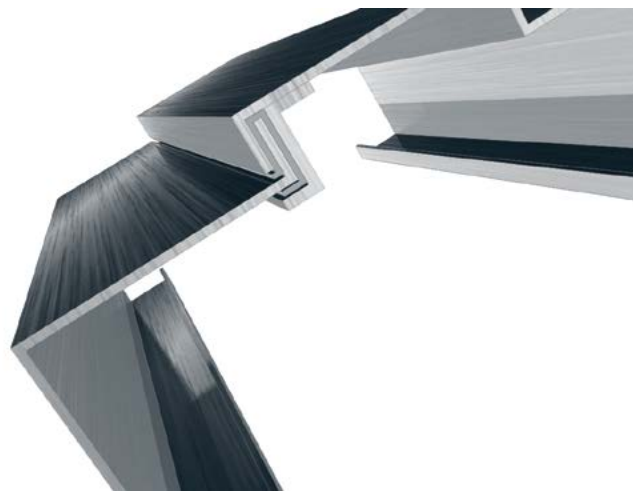

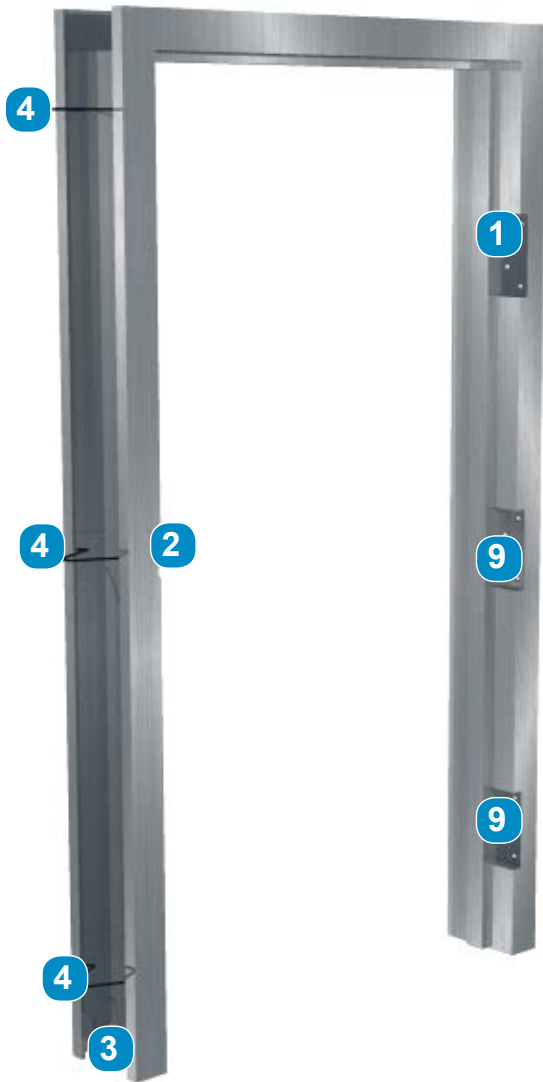

ILLUSTRATION:

- 1- 10 gauge angular hinge reinforcement
- 2- ANSI A115.1 strike preparation (ASA)
- 3- Floor anchor (ATT #3)
- 4- Masonry wall anchor(ATT #5)
- 5- Existing wall anchor (ATT #6)
- 6- Steel stud anchor (ATT #8)
- 7- Masonry wall anchor (ATT #4)
- 8- Wood stud anchor (ATT #7)
- 9- 10 gauge hinge reinforcement

1



2



3



SEVERAL TYPES OF ANCHOR:

4



5

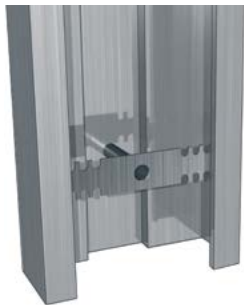

6



7



8



N.B.: Other hardware preparations are also available upon request.

Architectural frames

Concerned about detail, Métalec designs its architectural frames according to quality manufacturing and finish standards that meet the requirements of the industry professionals.

From their design, these frames can be manufactured in various ways: door frame with side lite or transom. They are also available in window frames. For standard or custom profiles, Métalec can supply architectural frames suitable for any project.

Design

- The architectural frames are manufactured using 18, 16, 14 or 12 gauge galvanized steel;
- The joints and corners of the architectural frames are welded and sanded on the surface and covered with a primer;
- Glazing beads are cut, adjusted and fixed in the openings with an oval head tapping screw.
- The frame anchors are welded or supplied with the frame according to the wall composition;
- The frames are prepared to receive the specified hardware.
- A 20, 45 or 90 minute fire rating is available upon request;
- The architectural frames, made using 16 or 14 gauge steel, are also available with a thermally broken profile for the outside openings. All of the mullions and midrails are insulated in factory with a fiberglass insulating material before the final assembly. When the assembly is done, a latex sealer is applied on the outside horizontal assembly joints to eliminate possible water infiltration.



ILLUSTRATION:

- 1- Perimeter
- 2- Corner assembly
- 3- Midrail
- 4- Bottom perimeter
- 5- ANSI A115.1 strike preparation (ASA)
- 6- 10 gauge hinge reinforcement
- 7- Mullion

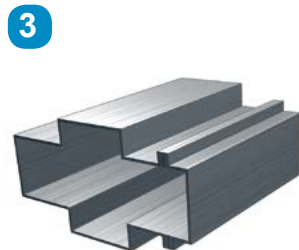
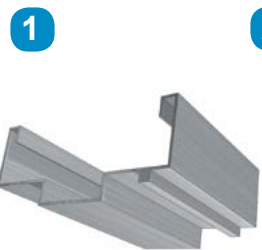

N.B.: Other hardware preparations are also available upon request.

Acoustical doors and frames

Uses

Among its product line, Métalec manufactures acoustic steel doors having all of the ASTM acoustic requirements:

- E336 Standard Test Method for Measurement of Airborne Sound Insulation in Building.
- E413 Standard Classification for Determination of Sound Transmission Class (STC).
- C423 Sound Absorption and Sound Absorption Coefficients by the Reverberation Room Method.

Métalec offers complete sets including the door, the frame, the acoustic perimeter seal, the bottom seal and the aluminium treshold.

- Acoustic degree available: STC-36, STC-40, STC-42, STC-44.
- Product available with fire resistance up to 3 hours (180 min.).

FRAME

Frame description

- The acoustical steel frames from the "CS" series are manufactured using 14 or 16 gauge galvanized steel;
- The frame has precise mitred corners. These corners are linked with a continuous weld on the inside faces of the mitred corners;
- All welded corners are ground smooth and primed to achieve a good looking finish;
- The steel frames have two temporary spreader bars welded at the base of the frame, six frame anchors adapted to various types of wall construction and two floor anchors;
- The frames are mortised, reinforced, drilled and threaded in order to receive three 0.180" heavy weight hinges measuring 114 mm x 102 mm (4-1/2" x 4") and one ASA strike;
- The hinge and the strike reinforcements are protected by mortar boxes;
- The steel frames are manufactured with a reinforcement for a surface-mounted door closers;
- The frames are provided with a label indicating the Sound Transmission Classification rating (STC).

DOOR

Door description

- The acoustic steel door from the "PI" series are manufactured using 18, 16 or 14 gauge galvanized steel;
- The door is perfectly smooth, without visible joints on the faces and edges;
- The door edges are beveled, 3 mm x 51 mm (1/8" x 2"). 16 gauge steel end channels are outcrop welded at the top and the bottom of the door;
- Inside the door, all the voids are completely filled with an acoustic core specific to Métalec;
- The door is prepared to receive three 0.180" heavy weight hinges measuring 114 mm x 102 mm (4-1/2" x 4");
- The door has a standard cylindrical lock preparation (161). In addition, the door is reinforced for a surface mounted door closer and automatic door bottom;
- A label is applied indicating the Sound Transmission Classification rating (STC).

STC-42

"STC-42" acoustic system description

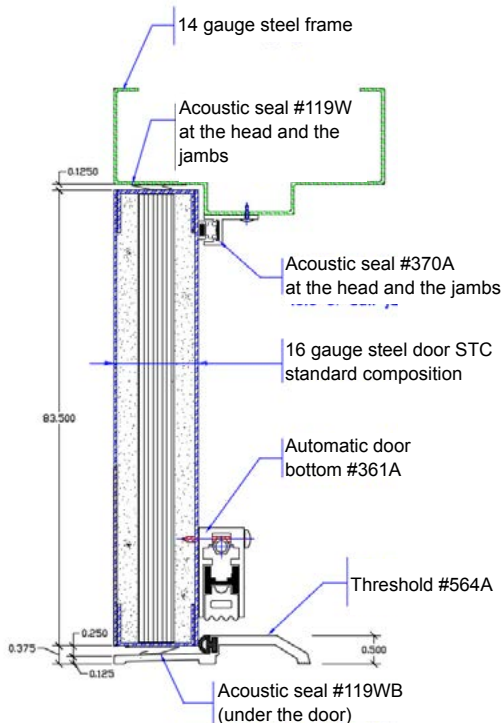

Illustration: STC-42

(MANUFACTURER "ZERO")

The acoustic system is made up of these following elements:

- Magnetic acoustic seal #370A installed on the door stop;
- Compressible acoustic seal #119W installed on the frame jambs and head (as illustrated), and under the door;
- Surface mounted automatic door bottom #361A;
- Aluminium threshold #564A.

To meet the specified STC rating, only Métalec acoustic seals can be used.

Steel doors

Over the years, Métalec has established a solid reputation in the steel door manufacturing area of expertise for commercial, industrial and institutional purposes.

The Métalec steel doors are offered in several sizes with a variety of designs and cores. They are also available with a 20, 45, 90, or 180 min. fire rating. A label is affixed on the product to certify the fire resistance period.

“PS” SERIES

Technical details

- Métalec steel doors are manufactured using 20, 18, 16 or 14 gauge galvanized steel;
- The door faces are perfectly smooth, without visible joints;
- The door panels are vertically assembled one to each other by a mechanical lock seam with flush welding near the hardware perforations;
- The door edges have a bevel of 3 mm x 51 mm (1/8" x 2");
- 16 gauge steel end channels are welded by electric resistance at the top and the bottom of the door every 152 mm (6") center to center;
- The non-insulated steel doors have a full honeycomb core made of 16 kg/m³ (1.0 lb/cu.ft) density kraft paper with 25 mm (1") cell size, laminated to the door faces by a polyurethane base adhesive;
- The insulated doors have a 54 kg/m³ (3,4 lb/cu.ft) density polyisocyanurate sheet core with a thermal resistance of RSI 2.0 (R-12.9); or a 16 kg/m³ (1,0 lb/cu.ft) density polystyrene sheet core with a thermal resistance of RSI 1.54 (R-8,75), laminated to the door faces by a polyurethane base adhesive;
- The doors are mortised for three standard hinges of 114 mm x 102 mm (4- 1/2" x 4");
- The hinge reinforcements are made with 10 gauge steel, and the top hinge is reinforced to have additional stiffening bend for high frequency strength;
- The doors are prepared for a standard cylindrical lock or reinforced for a surface-mounted panic bar or for a "push/pull" handle;
- Door closer reinforcement made of 16 gauge steel channel are installed at the top of all steel doors. When the door is reversible, a door closer reinforcement is added at the other end of the door. In the insulated steel doors, all the channels used as reinforcements are filled with the same insulating material as the door.

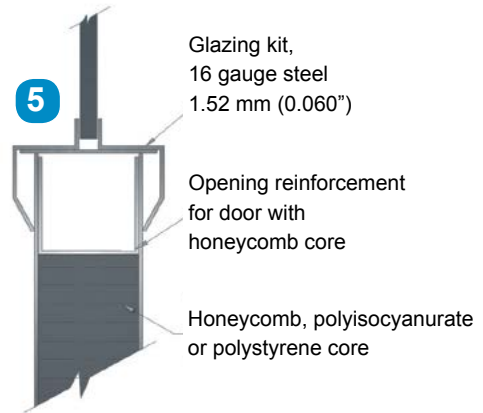
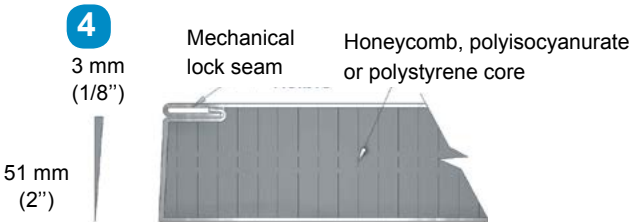
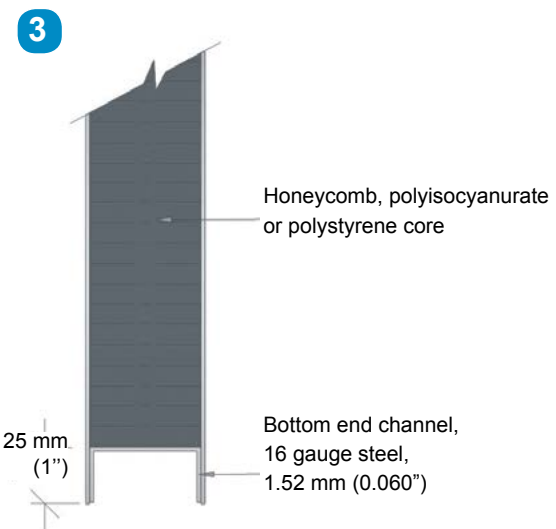
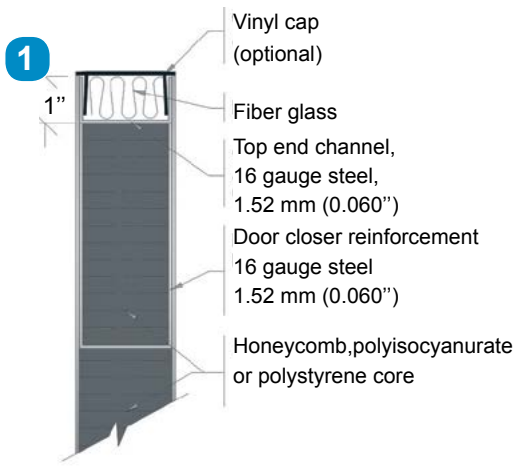

6 Standard cylindrical lock preparation (161) at 70 mm (2-3/4")



Steel doors

“PRV” SERIES

Technical details

- Heavy duty doors from the “PRV” series are available in 18, 16 and 14 gauge steel;
- These doors are designed to withstand high frequency use. They have been used in schools, hospitals, detention centres and recreational buildings;
- Using essentially the same manufacturing process as the “PS” series, these doors have vertical 20,18 or 16 gauge steel reinforcements bonded to the door faces at every 152 mm (6”) on center, or welded when a fire rated certification is required;
- The voids between the vertical reinforcements can be filled with polyisocyanurate, polystyrene, honeycomb kraft paper or a fiberglass insulating material;
- The door faces are assembled vertically one to each other by a mechanical lock seam with flush welding near the hardware perforations.

Options

- The door faces are vertically assembled one to each other by a fully welded joint on each side and ground smooth.
- A 14 gauge steel vertical channel reinforcement is welded at the joint on each side to strengthen the assembly. A primer is applied all over the joint.
- These doors are also available with a fire resistance of 45, 90 or 180 min.

PRVA

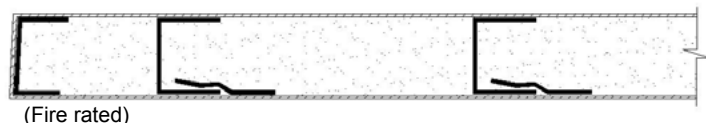

PRVB

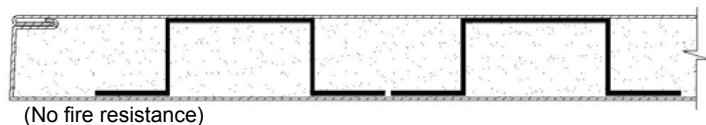

PRVC

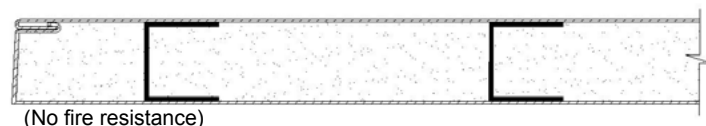

“PCR” SERIES**Technical details**

- The doors from the “PCR” series have a temperature rise core designed to limit temperature rise on the non exposed door face up to 250° C, thus allowing the people being in the building to safely evacuate the area;
- The doors are designed and tested to provide a fire resistance period up to 3 hours (180 min.);
- The doors are provided with a label indicating the degree of temperature and duration of fire resistance: 250°F for 30 min. or 450°F for 60 min. (250°C for 60 min.);
- Essentially built as the “PS” series the “PCR” doors have a mineral fibre core approved by WHI laboratory. This core is laminated to the door faces by a polyurethane base adhesive.

STEEL DOORS**Options**

- All of these designs are also available in Z275 (G90) galvanized steel;
- Vinyl caps installed at the top of the doors for exterior openings;
- Steel caps installed at the top and the bottom of the doors;
- Mechanical lock seams welded at every 152 mm (6”) center to center grinded, filled with metallic paste, ground smooth and primed;
- Other hardware preparations are also available upon request.

Glazed openings**MAXIMUM LIMITATIONS OF GLAZED OPENINGS IN FIRE DOORS**

- 180 min. fire rated door (no glazing allowed)
- 90 min. fire rated door (max. 645 cm² (100 in²) per door)
- 45 min. fire rated door (max. 8361 cm² (1296 in²) per opening and max. dimensions 54”)
- Several designs of doors with glazed openings are available and Métalec offers you different trim kits:

“NL” - “LNL” - “DNL” - “HG” - “FGWR” - “VL” - “CGL” - “FG” - “JDS” - “OG” type
(See Glazed opening types hereafter)

Steel doors

STEEL DOORS

Opening types

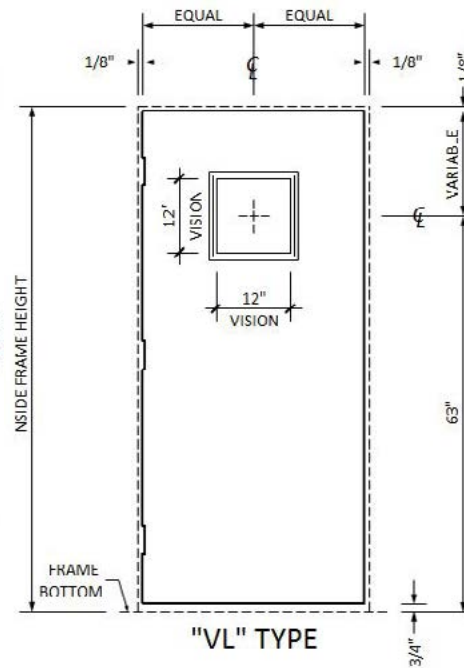
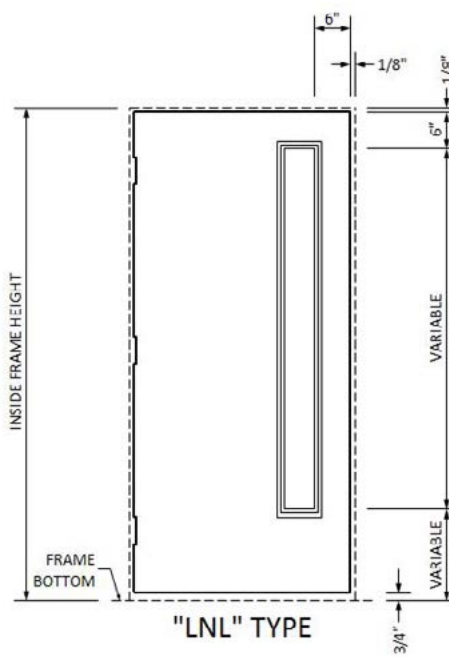
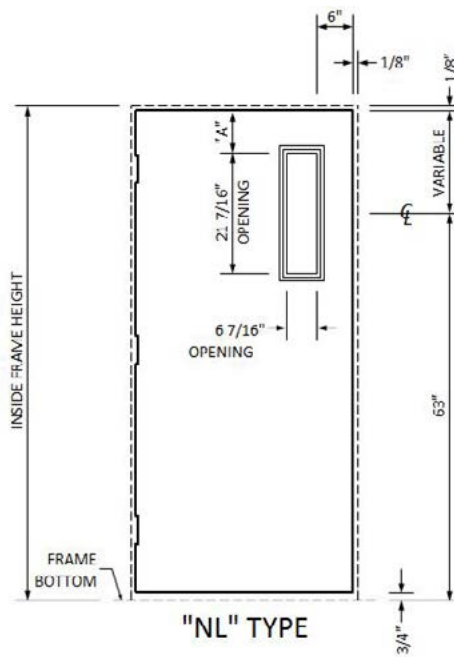
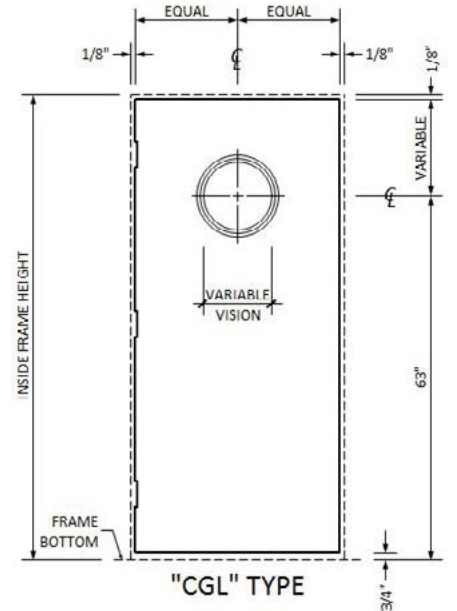
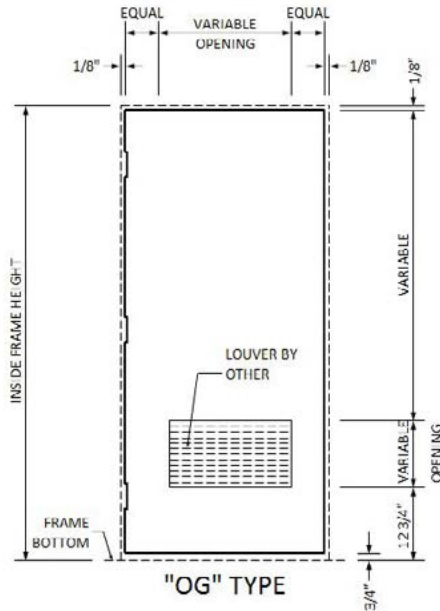
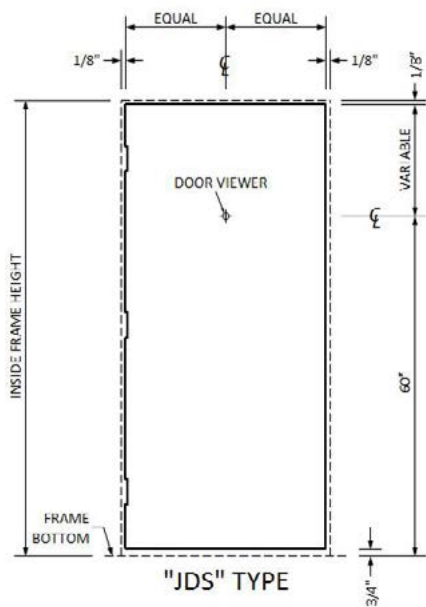

STEEL DOORS

Opening types (continued)

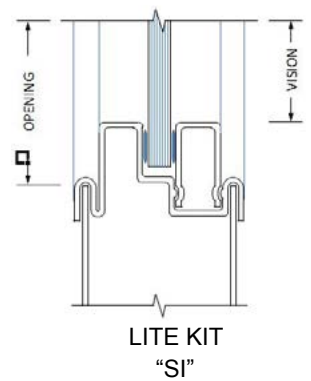
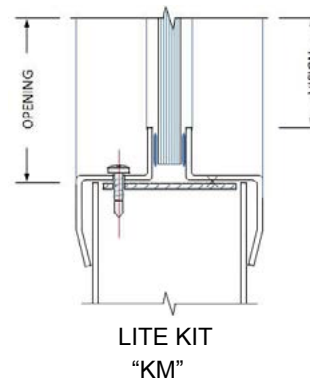
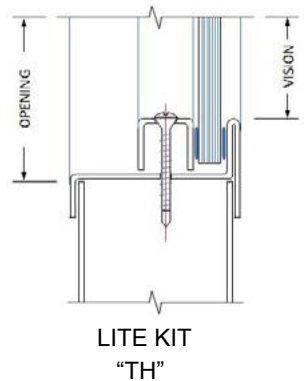
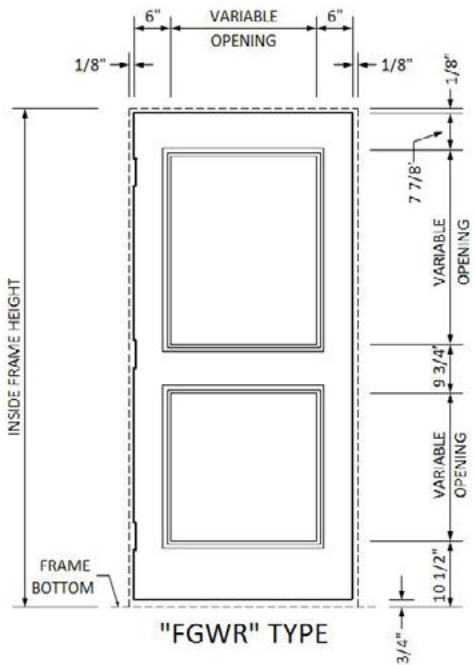
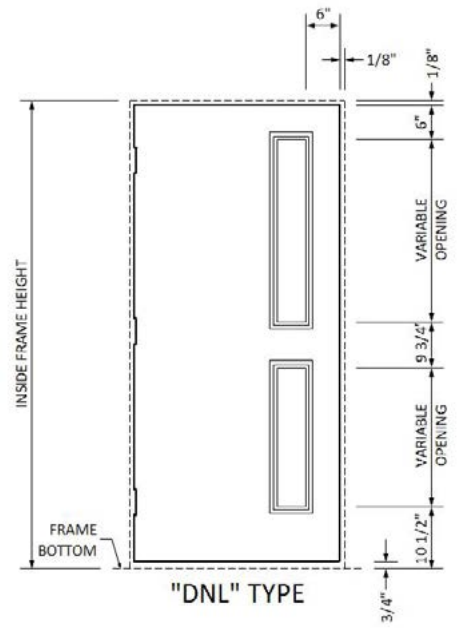
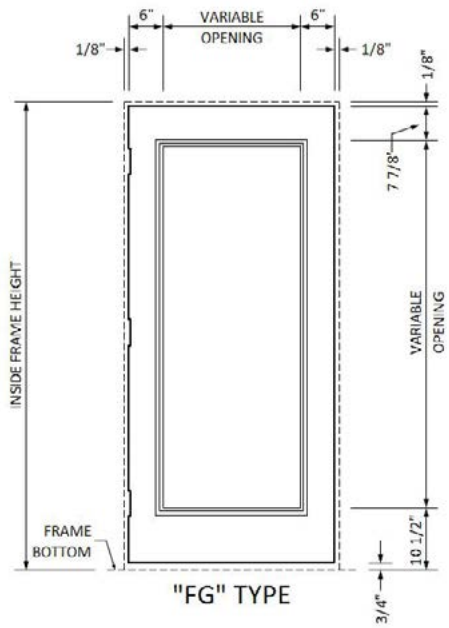
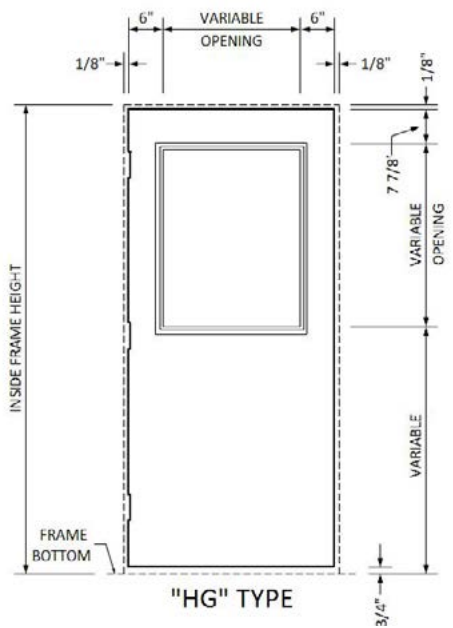

"TH" and "KM" available for 1/4" to 1" thick glass
 "SI" available for 1/4" thick glass only

Security doors

Métalec security doors are designed to withstand heavy duty and high frequency usage. This door type provides solidity and longevity demanded in police stations and institutional security projects.

SECURITY DOORS

Technical details

- Métalec manufactures its security doors using 1.6mm (16g) ZF120 satin finish galvanized steel (A40) or 2mm (14g) steel;
- The doors will be manufactured with a 45mm (1-3/4") or 50mm (2") thickness;
- The doors are perfectly smooth without visible joints on their faces and asperity on their security side;
- The door faces are vertically assembled one to each other with a fully welded joint on each side, ground smooth with a 10 gauge steel reinforcement;
- The door edges have a bevel of 3mm x 51mm (1/8" x 2") allowing unconstrained operation;
- The door has a plywood core laminated on the door faces with a polyurethane base adhesive offering a maximum bond. The perimeter of the core and the openings for glass and hardware are reinforced with a 2.5mm steel profile (12 gauge), the profiles are welded at their junctions and screwed to the panel;
- The hinge reinforcement is part of the structural perimeter of the door. The steel profile is 2.5mm thick with a 6mm (1/4") steel reinforcement;
- The prison lock on the security side is reinforced with a 3mm steel plate (1/8") on the door core, thereby increasing the level of strength and safety;
- A 3mm (10g) steel end channel is welded to the top and bottom of the door;
- A 3mm (10g) steel reinforcement is attached to the door core to receive the closer and door pull;
- No fire certification available.

Options - Glazed openings

- The periphery of the opening is composed of 2.5mm (12g) "L" shaped steel, welded to the door skins;
- The opening on the security side is smaller than the opposite (corridor/less secure) side to safely support the glass;
- The glazing beads are made with solid steel of 19 mm x 19 mm (3/4" x 3/4") and fixed with TORX security screws.

N.B.: The opening glass dimensions will vary depending on the customer requirements.

SECURITY DOORS

Options-Serving hatch

- The periphery of the opening is composed of 2.5mm (12g) "Z" shaped steel, welded to the door skins;
- The serving hatch is composed of 2 steel thicknesses. The security side in 5mm (3/16") and the corridor side in 3mm (1/8");
- The core is composed of a laminated plywood panel secured with a polyurethane adhesive;
- The hatch can either be manufactured for an integrated handle or reinforced for push/pull hardware;
- The continuous hinge is sturdy and welded to the hatch;
- Two choices are available for the opening, 90 or 180 degrees;
- The preparation of the mortise lock is located in the door and the strike preparation in the hatch.

Options - Sound grid

- The periphery of the opening is composed of 2.5mm (12g) "U" shaped steel, welded to the door skins;
- The security side has 5mm (3/16") perforations in staggered rows, the last row of perforations is located at the same height as the bottom reinforcement to allow draining;
- The door skin on the less secure side includes a 3mm (1/8") stainless plate with 5mm staggered perforations plus a 30mm (13/16") deflector, secured with TORX security screws.

Security doors



Less secure side,
Elevation



Security side,
Elevation

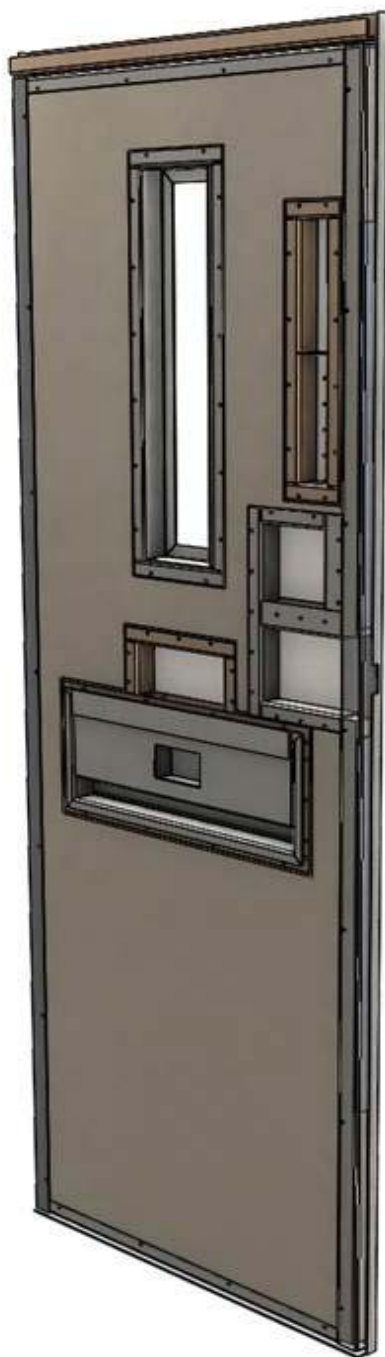

Reinforced core details

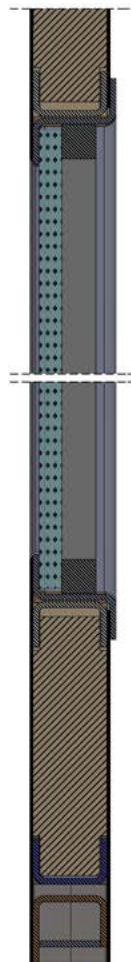

Door top
(Inside side view)



Door bottom
(Inside side view)

Stainless steel doors and frames

Métalec stainless steel doors and frames becomes a judicious choice when you need greater corrosion resistance or an aesthetical look.

Technical details

Métalec manufactures its doors from a #304 stainless steel type with a #4 finish for projects where stainless steel beauty and prestige are displayed prominently. For projects that require durability, Métalec uses a #316 stainless steel type with a #4 finish which offers a higher resistance to corrosion. Stainless steel products have a variety of applications where they present higher performance:

- > Public pools
 - > Food processing factory
 - > Laboratories
 - > Chemical product warehouse
 - > Automatic car wash
-
- The frames are manufactured using 18, 16 or 14 gauge stainless steel and can be welded or knockdown;
 - The doors are built using 18, 16 or 14 gauge stainless steel, such as the "PS" or "PRV" series;
 - The frames and doors are strengthened, mortised, drilled and threaded in order to receive the specified hardware;
 - All the required components for this type of door are manufactured with stainless steel.

Stainless steel advantages

There are two types of stainless steel: the austenitic structure gathering A.I.S.I. 300 (301 to 348) grades and those of ferritic structure gathering A.I.S.I. 400 and 500 (403 to 446, 501 and 502) grades. The austenitic stainless steels generally have less carbon, two times more manganese, and also, they have a high content of nickel when the ferritic steels contain none or few.

For the manufacturing process of its doors and frames, Métalec uses an austenitic stainless steel. Its remarkable resistance to corrosion is due to a chromium-rich oxide protective film which forms on the surface when exposed to ambient oxygen.

There is no doubt stainless steel is a contemporary and durable choice for all architectural projects. Métalec stainless steel doors and frames are chosen for the following characteristics:

- Aesthetics;
- Excellent resistance to the corrosion and to chemicals;
- Heat and fire resistance;
- Easy maintenance.



#304 stainless steel type with a #4 finish

Certifications and specifications

Steel specifications

For commercial, institutional and industrial constructions, Métalec uses a wiped finish galvanized steel designed especially to offer the superior durability which is required in steel doors and frames.

Moreover, a wiped finish galvanized steel offers a uniform surface and a very great bond to apply the paint finish. This steel offers better resistance to corrosion than the cold laminated steel, primed and painted. This material is commercially designed under the name of “galvanneal” or “satin coat”.

A: STANDARD STEEL

- Cold laminated steel of commercial quality according to the “ASTM A653/A653M” standard
 - Designation finish ZF120 (A40) 120 g/m² (-0.40 oz/sq.ft.)
- Minimum total covering

B: OPTIONAL STEEL

- Cold laminated steel of commercial quality according to the “ASTM A653/A653M” standard
 - Designation finish Z275 (G90) 275 g/m² (-0.90 oz/sq.ft)
- Minimum total covering.

Finish

The surfaces where the iron-zinc alloy has been damaged or removed during the manufacturing process, are patched with a primer meeting the “CAN/GCSB 1-GP-181” standard.

All the surfaces have to be free of dust, oil or grease to optimize the paint bond.

The top coat (paint) used on our metal products must be of quality and suitable for this type of application.

Fire resistance certification (WHI)

Putting emphasis on its customers' satisfaction, Métalec is continually developing new fire rated products to meet the constant growing demand of the market.

Among its vast range of products, Métalec manufactures fire rated steel doors and frames according to your needs.

- Métalec are approved by the Warnock Hersey (ITS) laboratory highly recognized in the industry;
- The steel doors and frames have been verified, inspected and approved in conformance with:
 - CAN/ULC-S104-M80
 - UBC7-2(1994)
 - UL10(b)
 - NFPA252
 - NFPA80
 - ASTM E152 (Standard methods of fire tests of door assemblies)

A regular verification is made at the factory by a WHI laboratory inspector during the manufacturing.

Métalec has a full range of fire listed products with Warnock Hersey and are available with the following fire ratings:

- 20 min. (D)
- 45 min. (C)
- 90 min. (B)
- 180 min. (A)

See the Fire Labelling Guide tables at the end of this brochure.

Fire rated DOORS

Maximum rating (hours)	Door types			Maximum door size	Steel thickness (gauge)	Door core	Glazed openings (maximum surface)
	Single	Double					
		Regular	Double egress				
3	X	-	-	1067 mm x 2286 mm (42" x 90")	20-18	Honeycomb	n/a
3	X	-	-	1067 mm x 2388 mm (42" x 94")	20-18-*	Honeycomb	n/a
3	X	-	-	1067 mm x 2134 mm (42" x 84" (120") avec imposte)	20-18	Honeycomb	n/a
3	-	X	-	2134 mm x 2286 mm (84" x 90")	20-18	Honeycomb	n/a
3	X	-	-	1220 mm x 2134 mm (48" x 84")	16	Vertical stiffeners (wool)	n/a
3	-	X	-	2440 mm x 2134 mm (96" x 84")	16	Vertical stiffeners (wool)	n/a
3	X	-	-	1220 mm x 2134 mm (48" x 84")	18-16-14	STC-36 to STC-44	n/a
3	-	X	-	2440 mm x 2134 mm (96" x 84")	18-16-14	STC-36 to STC-44	n/a
3**	X	-	-	1220 mm x 2440 mm (48" x 96")	20-18-16	Temperature rise	n/a
3**	-	X	-	2440 mm x 2440 mm (96" x 96")	20-18-16	Temperature rise	n/a
1 1/2	X	-	-	1220 mm x 2440 mm (48" x 96")	16	Vertical stiffeners (Temperature rise or fiberglass)	0.065 m ² (100 po ²)
1 1/2	-	X	-	2440 mm x 2440 mm (96" x 96")	16	Vertical stiffeners (Temperature rise or fiberglass)	0.065 m ² (100 po ²)
1 1/2	X	-	-	1220 mm x 2440 mm (48" x 96")	20-18-16	Honeycomb or temperature rise	0.065 m ² (100 po ²)
1 1/2	-	X	X	2440 mm x 2440 mm (96" x 96")	20-18-16	Honeycomb or temperature rise	0.065 m ² (100 po ²)
1 1/2	X	-	-	915 mm x 2134 mm (36" x 84")	14	Honeycomb	0.065 m ² (100 po ²)
1 1/2	-	X	-	2134 mm x 2134 mm (84" x 84")	14	Honeycomb	0.065 m ² (100 po ²)
1 1/2**	X	-	-	915 mm x 2134 mm (36" x 84")	20-18-16	Polystyrene or polyisocyanurate	0.065 m ² (100 po ²)
3/4	X	-	-	1220 mm x 2440 mm (48" x 96")	20-18-16	Honeycomb	0.84 m ² (1296 po ²)
3/4	-	X	X	2440 mm x 2440 mm (96" x 96")	20-18-16	Honeycomb	0.84 m ² (1296 po ²)
3/4	X	-	-	915 mm x 2134 mm (36" x 84")	14	Honeycomb	0.84 m ² (1296 po ²)
3/4	-	X	-	2134 mm x 2134 mm (84" x 84")	14	Honeycomb	0.84 m ² (1296 po ²)

* Stainless steel ** Positive pressure

Fire rated FRAMES

Maximum rating (hours)	Frame types	Maximum frame size	Steel thickness (gauge)	Minimum wall thickness	Transom
3*	Single frame with transom	1220 mm x 3048 mm (48" x 120")	16*	90 mm (3 1/2")	Panel
3*	Double frame with transom	2440 mm x 3048 mm (96" x 120")	16*	90 mm (3 1/2")	Panel
3*	Single frame	1220 mm x 2440 mm (48" x 96")	16*	90 mm (3 1/2")	n/a
3*	Double frame	2440 mm x 2440 mm (96" x 96")	16*	90 mm (3 1/2")	n/a
1 1/2	Double egress frame	2440 mm x 2440 mm (96" x 96")	16	90 mm (3 1/2")	n/a
1 1/2	Bay-side frame	3048 mm x 2185 mm (120" x 86")	18	114 mm (4 1/2")	Panel
1 1/2	Single frame	1067 mm x 2134 mm (42" x 84")	18	114 mm (4 1/2")	n/a
1 1/2	Double frame	2134 mm x 2134 mm (84" x 84")	18	114 mm (4 1/2")	n/a
3/4*	Single frame with transom	1220 mm x 3048 mm (48" x 120")	16*	90 mm (3 1/2")	Panel or wired glass
3/4*	Double frame with transom	2440 mm x 3048 mm (96" x 120")	16*	90 mm (3 1/2")	Panel or wired glass
3/4*	Side lite frame (or window)	3048 mm x 2185 mm (120" x 86")	18	114 mm (4 1/2")	Panel or wired glass

* Steel or stainless steel

NOTE: The maximum area of exposed glass is 0.84 m² (1,296 in²) (example: 915 mm x 915 mm (36" x 36")) and must not exceed either 1.372 m (54") in height or 1.372 m (54") in width.

Métalec is proud to be a member of the following associations:



MÉTALEC

STEEL DOORS & FRAMES

Québec

2150, Léon-Harmel
Québec (Quebec) Canada G1N 4L2

Tel.: (877) 683-2431

(418) 683-2431

Fax.: (418) 683-1878

info@metalec.com

www.metalec.com

Montréal

7800, Bombardier
Anjou (Quebec) Canada H1J 2G3

Tel.: (514) 355-5431

Fax.: (514) 355-6896

Strength of expertise